

# Data Sheet

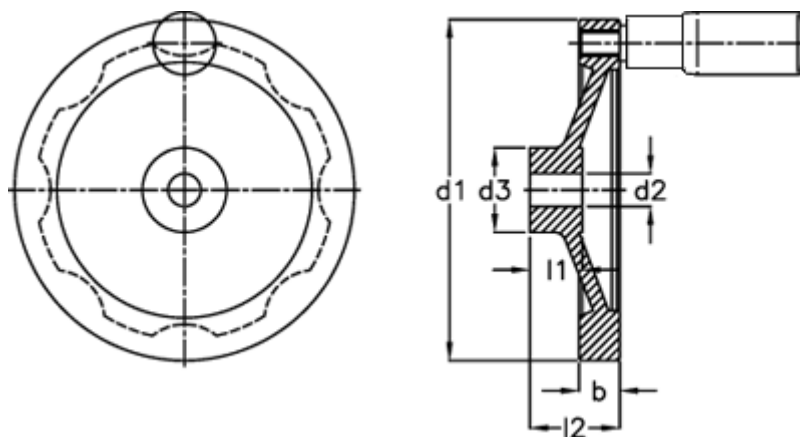

Article number: 201119280  
Description: E+G Handwheel  
GN 323-100-K10-R

## Measures



b	= 14.0
d1	= 100
d2 H7	= 10
d3	= 28
Handle	= 18
l1	= 17
l2	= 30